

LIM-313-#

Planar multi channel pyroelectric detector

Description:

three channel; TO8 housing; medium chip size; thermal compensation; JFET; voltage mode;

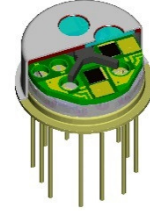

Housing:

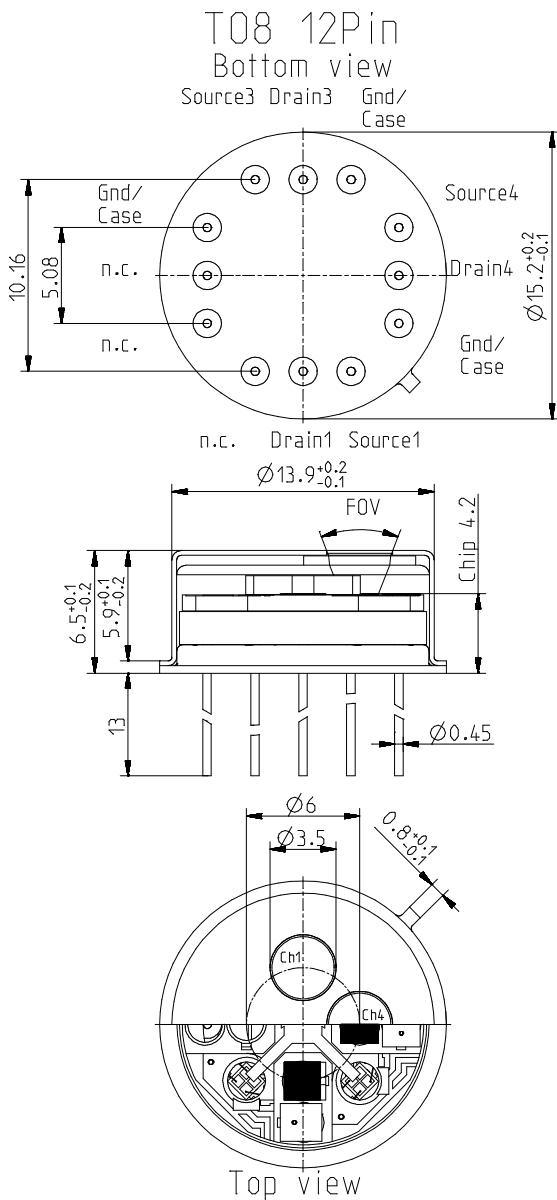

Maximum current between Case and the "Case"-Pin 10 mA!

Pin Assigment:

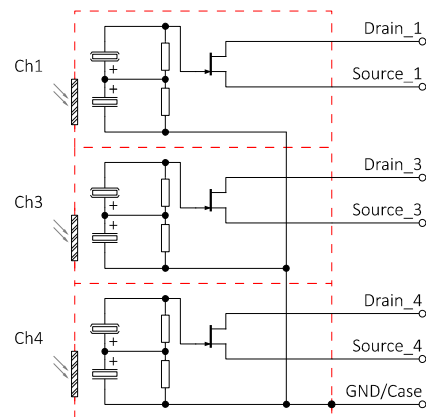

Frequency Response:

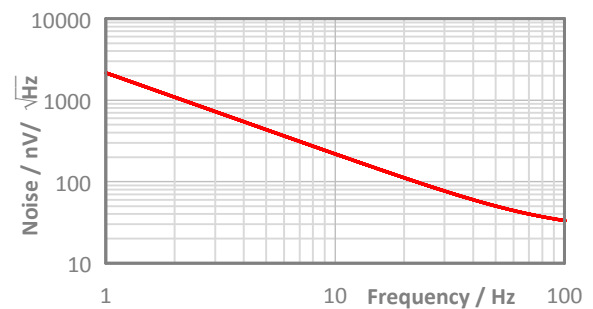
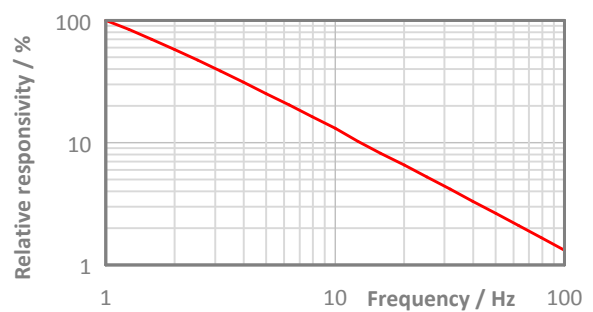

LIM-313-#

Planar multi channel pyroelectric detector

Test Circuit:

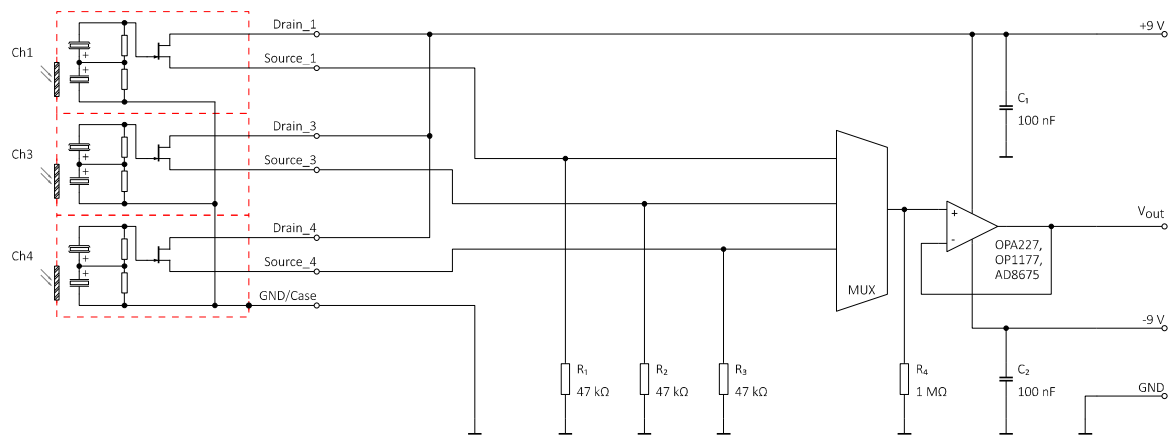

Parameters:

Aperture size	nom	ø9.5 mm, single channel ø3.5 mm
Element size / type	nom	2.0 × 2.0 mm ² lithium-tantalate with black layer
Thermal time constant	typ	100 ms
Electrical time constant	typ	2 s
Polarity	nom	Positive signal by positive IR flux change
Voltage responsivity (rms) {500 K, 10 Hz, 25 °C, without filter/window}	min	300 V/W
Noise density (rms) {10 Hz, BW 1 Hz, 25 °C}	max	280 nV/√Hz
Detectivity {500 K, 10 Hz, 1 Hz, 25 °C, without filter/window}	typ	3.5E+08 cmVHz/W
Offset voltage {opt. Drain current = 10 ... 100 μA}	nom	0.4 ... 1.5 V
Drain source voltage	max	18 V
Operating / Storage temperature	nom	-40 ... +85 °C
IR window		Combinations of all InfraTec standard narrow band pass filters are available. Customized filters upon request.
Filter sizes	nom	Rectangular filters: (4.20 × 4.20) mm ±0.1 mm Circular filters: not applicable Standard thickness: 0.50 mm +0.2/-0.1 mm Thickness range 0.70 ... 1.10 mm on request
Field of View	min	CaF2 or BaF2; 0.4 mm thick: not applicable Silicon substrate; 0.5 mm thick: 40°

InfraTec reserves the right to change these specifications at any time without notification.