

Windows and Filter

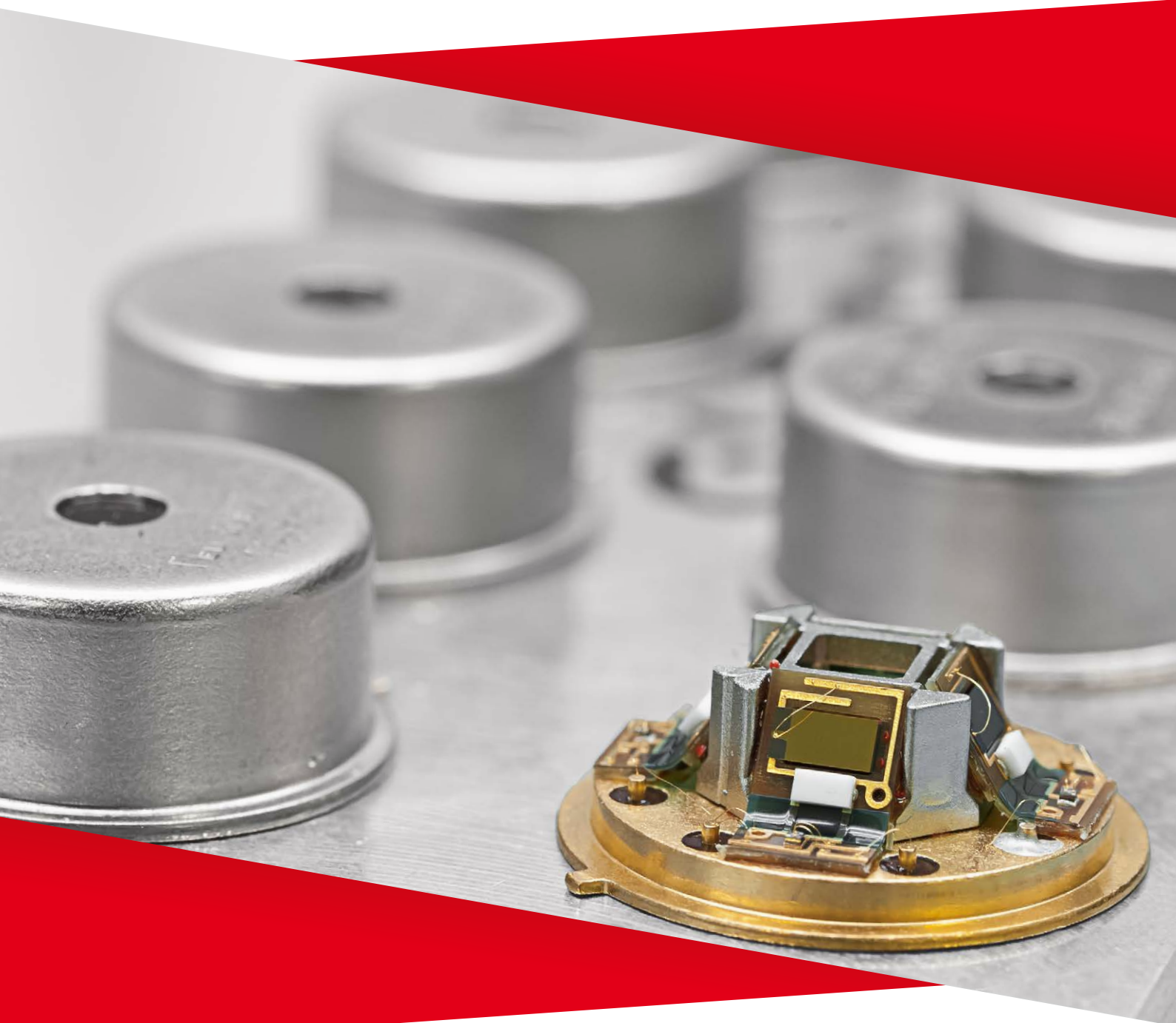

The Products

2.4 Filters and Windows

2.4.1 Basic Principles

The window of a detector is its interface to the optical system. It has to protect the internal components from environmental influences, while letting the spectral part of the infrared radiation relevant for the function pass through. For this purpose, very infrared-transparent materials are used. Since there is no ideal material for all applications, it is necessary to weigh up which properties are particularly important on a case-by-case basis. The transparency ranges, i.e. the spectral ranges, in which the window practically does not absorb, are very different. On the other hand, the different position of the absorption edge can be utilised specifically if radiation of a higher wavelength should not be detected. This is referred to as blocking. If necessary, windows can be provided with an anti-reflective coating (ARC). As a result, the transmission in a selected spectral range is improved considerably, which is important particularly in the case of materials with a high refractive index such as silicon, since reflection losses at the interfaces increase with the rising refractive index.

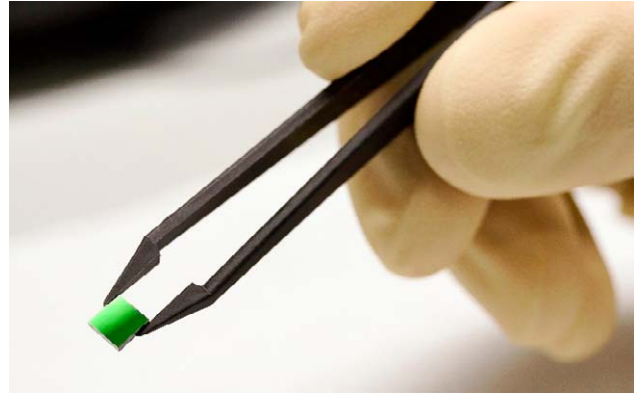

A window is referred to as filter if its transparency range is further limited by additional measures. Here, we differentiate between absorption filters and interference filters. The former are mostly used only in the visible range. InfraTec only uses interference filters. For this layer stacks of two dielectric materials with a different refractive index are applied alternately to a substrate made from a very infrared-transparent material on one side or both sides. Interference effects lead to a wavelength-dependent extinction or enhancement of the incident electromagnetic wave. Thus, different spectral ranges of higher and lower transmission result, which is used for producing various types of optical filters and anti-reflective coatings.

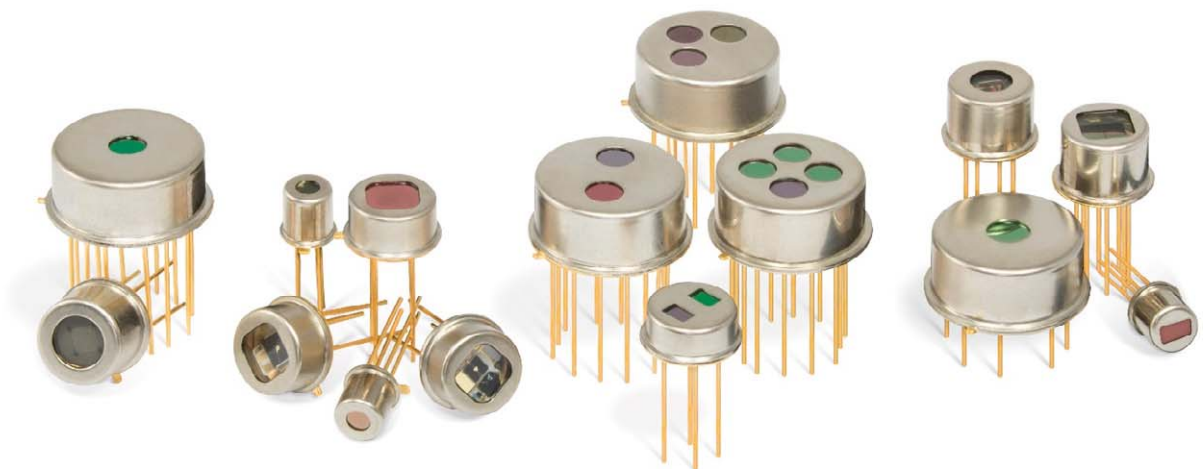

The Products

Depending on the application, the filter must let radiation pass through different spectral ranges, which concerns their position as well as their limitation after only one or both sides. A longwave pass (LWP) only lets radiation pass through above a limit wavelength (cut-on). A shortwave pass (SWP), on the other hand, cuts off from a certain limit wavelength (cut-off). For example, silicon with an anti-reflective coating can act as a longwave pass, and calcium fluoride can act as a shortwave pass owing to the position of its absorption edge. A bandpass can be regarded as a combination of a long and short pass, where the transmission ranges overlap in such a way that a passband is formed. Depending on the width of this band, the filter is referred to as a wide bandpass (WBP) or narrow bandpass (NBP). The latter are particularly important for the gas analysis.

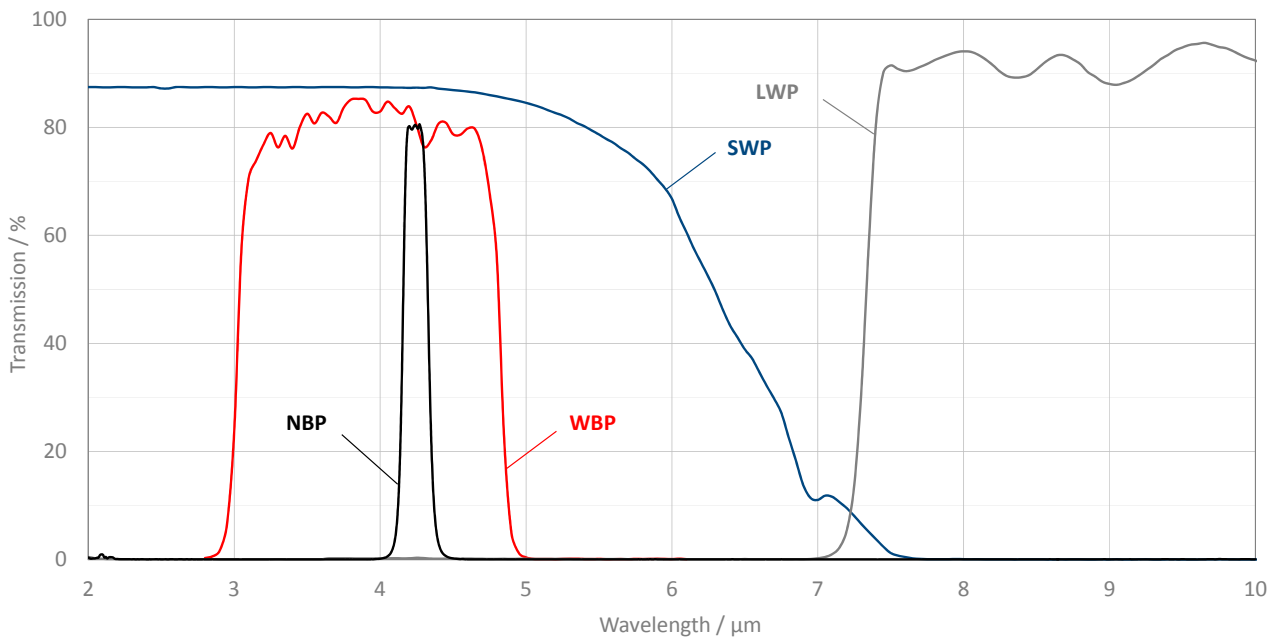

Diagram 1: Presentation of different bandpass filters

The Products

2.4.2 Bandpass Parameters

The transmission range of a bandpass is characterised by the centre wavelength CWL, half power bandwidth HPBW and peak transmission T_{pk} . The peak transmission should not fall below a value of 70 % so that the detector signal does not become too low. With the cut-on and cut-off wavelength ($\lambda_{cut-on}, \lambda_{cut-off}$) the transmission is exactly half of the peak transmission.

$$T(\lambda_{cut-off}) = T(\lambda_{cut-on}) = \frac{T_{pk}}{2} \quad \text{HPBW} = \lambda_{cut-off} - \lambda_{cut-on} \quad \lambda_{cut-off} > \lambda_{cut-on}$$

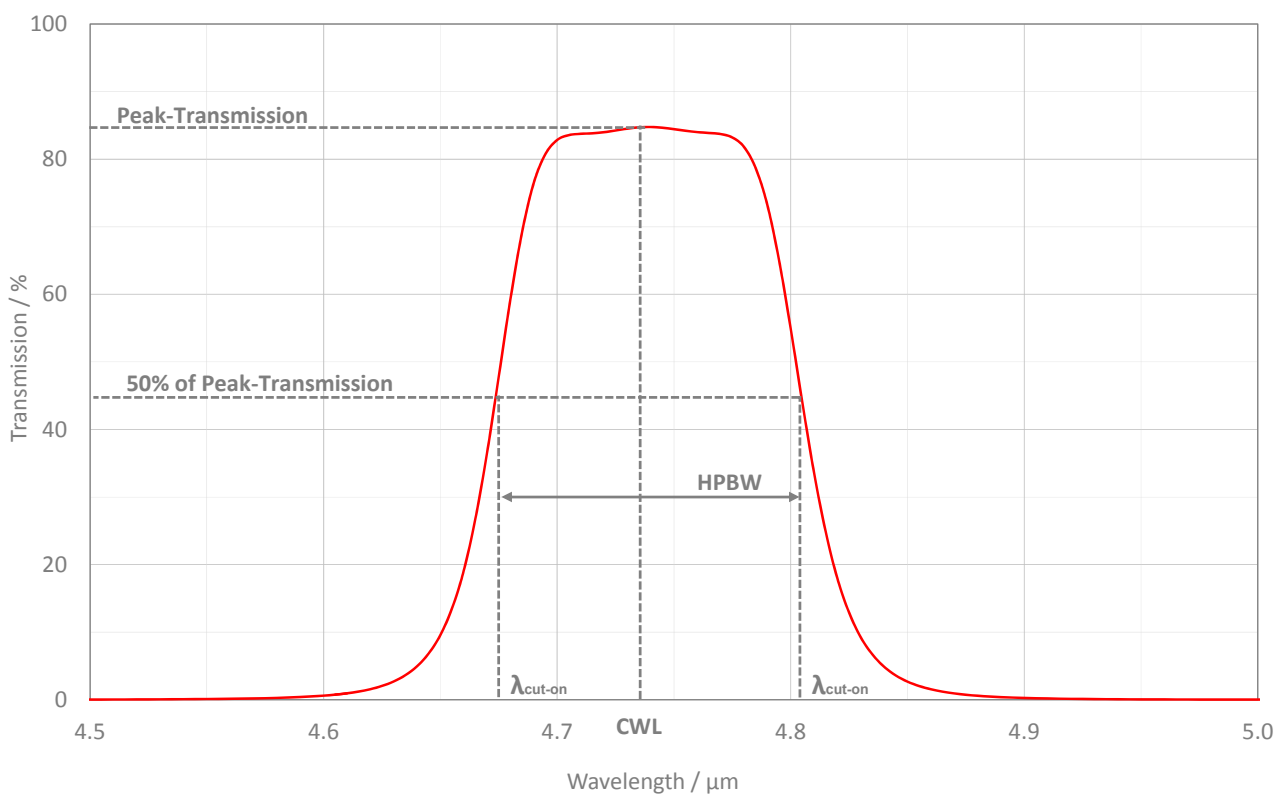

Diagram 2: Transmission range of a bandpass filter

The centre wavelength indicates the "middle" of the bandpass and is calculated from the cut-on and cut-off wavelengths¹:

$$\text{CWL} = \frac{\lambda_{cut-on} + \lambda_{cut-off}}{2}$$

Outside the passband, in the blocking range, the transmission of the filter should be as little as possible (< 0.1 ... 1%), since additional, otherwise disturbing signal parts result. Since these parts are not affected by the value to be measured, with which the bandpass is aligned, a transmission in the blocking range reduces the measuring sensitivity of the application.

¹ InfraTec uses for the definition of CWL the wavelength, not the wavenumber.

The Products

2.4.3 Standard Narrowband Filters

Narrowband filters are particularly well suited for the gas analysis thanks to their low half power bandwidth. Thus, even closely adjacent absorption bands of different gases can be clearly separated. The gas specified in the table corresponds to the typical application of the filter. In individual cases, however, it can make sense to use another gas band and thus a customised filter. The choice of filter always essentially depends also on which gases in what concentration exist in the mixture to be measured. This applies not only but especially to the reference filter. Hence, there is also a choice of several different standard filters for some gases.

When using the filters, it should be noted that the blocking, depending on the application, does not extend sufficiently wide in the longwave range for all filters (e.g. > 15 μm). Therefore an additional blocking element for the longwave range can be necessary in some cases.

Designation (CWL / HPBW)	Gas	Code	Tolerance of CWL / nm	Tolerance of HPBW / nm	Diagram
NBP 3.09 μm / 160 nm Reference	-	M	± 30	± 20	7
NBP 3.95 μm / 90 nm Reference	-	H	± 30	± 20	7
NBP 3.33 μm / 160 nm Methane	CH ₄	C	± 20	± 20	7
NBP 3.40 μm / 120 nm HC ²	HC	G	± 30	± 20	7
NBP 4.30 μm / 600 nm Flame	Flame	F	± 30	± 30	8
NBP 4.26 μm / 90 nm CO ₂ narrow	CO ₂	T	± 20	± 20	5
NBP 4.26 μm / 180 nm CO ₂ standard	CO ₂	D	± 20	± 20	5
NBP 4.27 μm / 170 nm CO ₂ high AOI	CO ₂	Z	± 30	± 20	5
NBP 4.45 μm / 60 nm CO ₂ long path	CO ₂	E	± 20	± 20	5
NBP 4.66 μm / 180 nm CO centred	CO	I	± 40	± 20	6
NBP 4.74 μm / 140 nm CO flank	CO	K	± 20	± 20	6
NBP 5.30 μm / 180 nm NO	NO	L	± 40	± 20	8
NBP 7.30 μm / 200 nm SO ₂	SO ₂	U	± 40	± 30	8

We will gladly answer your questions regarding the choice of filter at any time. On request we will offer more filters.

² Hydrocarbons

The Products

2.4.4 Standard Crystal Windows

Designation (incl. thickness)	Code	Material	Transmission > 80 %	Diagram
CaF ₂ 0.4 mm	60	Calcium fluoride	UV ... 11 μm	9
CaF ₂ 0.7 mm	61	Calcium fluoride	UV ... 10 μm	9
CaF ₂ 1.0 mm	62	Calcium fluoride	UV ... 10 μm	9
BaF ₂ 0.4 mm	63	Barium fluoride	UV ... 14 μm	10
BaF ₂ 1.0 mm	64	Barium fluoride	UV ... 13 μm	10
CsI 0.8 mm	65	Caesium iodide*	UV ... 50 μm	12
KBr 0.8 mm	66	Potassium bromide*	UV ... 30 μm	12
KBr 1.0 mm	67	Potassium bromide*	UV ... 30 μm	12
Sapphire 0.4 mm	68	Sapphire	UV ... 6 μm	11
Sapphire 0.6 mm	69	Sapphire	UV ... 6 μm	11
Sapphire 0.6 mm	69-S	Sapphire (soldered)	UV ... 6 μm	11
Si uncoated 0.5 mm	70	Silicon	1 ... 50 μm**	12

* With moisture protective coating

** Transmission approx. 50 %

2.4.5 Standard Silicon Windows

Designation	Code	Properties	Transmission > 70 %	Diagram
Si ARC 2 – 5 μm	10	Anti-reflecting coating	2 ... 7 μm	13
Si ARC 3 – 6 μm	11	Anti-reflecting coating	3 ... 7 μm	13
Si ARC 3 – 10 μm	12	Anti-reflecting coating	3 ... 12 μm	13
Si WBP 3 – 5 μm	13	Wideband pass	3 ... 5 μm	14
Si WBP 8 – 14 μm	14	Wideband pass	8 ... 14 μm	14
Si LWP 5.3 μm	15	Long pass	6 ... 15 μm	15
Si LWP 6.5 μm	16	Long pass	7 ... 14 μm	15
Si LWP 7.3 μm	17	Long pass	7.5 ... 12 μm	15

The Products

2.4.6 Thermal and Geometric Influences on the Spectral Parameters

The centre wavelength of the bandpass is also dependent on the angle of incidence of the incident radiation as well as on the ambient temperature and is normally specified for parallel radiation with an angle of incidence (AOI) of 0° at a temperature of 23 °C. The CWL shifts to higher wavelengths at higher ambient temperatures. If the angle of incidence is increased, however, the CWL shifts to shorter wavelengths. Both influencing factors affect the transmission and half power bandwidth to varying degrees. The shift of the CWL due to change of temperature is approximately linear, so that this can be characterised by a temperature coefficient (TC). The dependency on the angular drift of the CWL is more complex, however. Thus, only the difference for angles of incidence of 15° and 0° is specified in most cases.

The filter design is usually optimised for one of the two parameters. Due to the strong influence of the angle of incidence on the CWL, most InfraTec standard filters are offered in the low-angular-shift design. At low angles of incidence but fluctuating ambient temperature, a low-TC design can make more sense, however. For this reason, customer-specific filters are normally available both in the low-angular-shift and the low-TC design.

Classification of the InfraTec Standard Filter

Design	Standard filter code	CWL shift for AOI = 15°	CWL shift by temperature change
Low angular shift ³	C, E, F, H, I, K, L, M, T, U, Z	8 ... 20 nm	> 0.4 nm / K
Low TC ⁴	D, G	> 30 nm	0.2 ... 0.3 nm / K

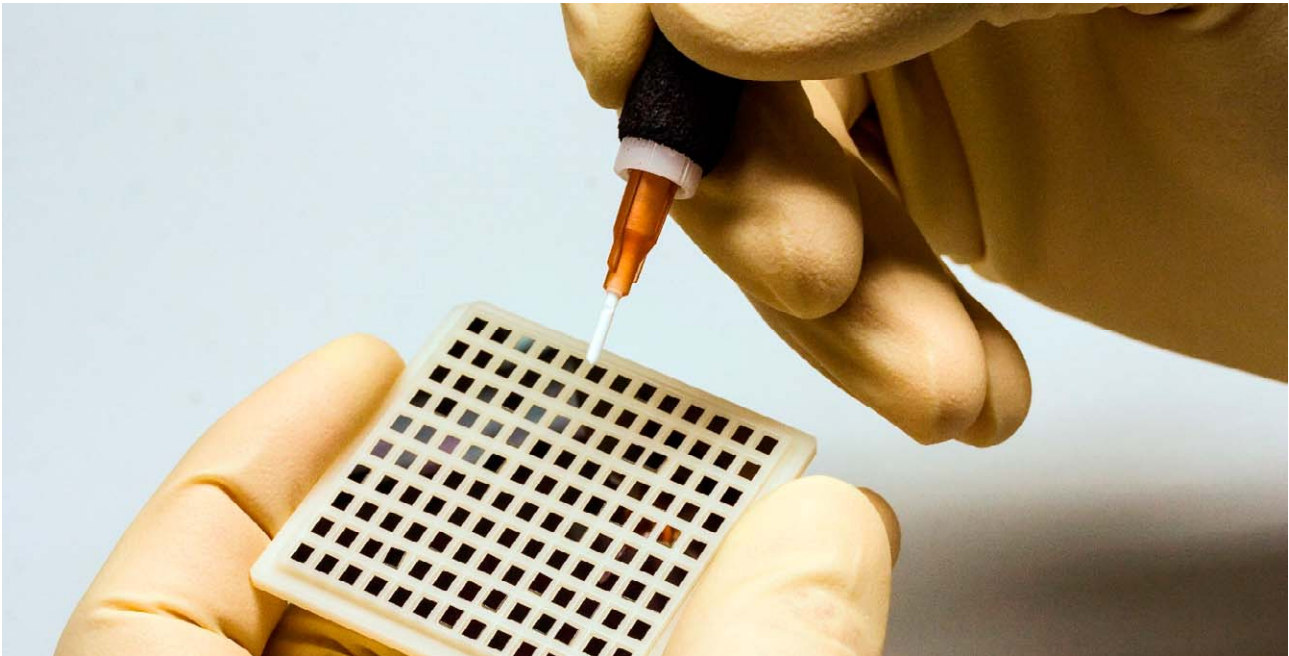

³ Low angular shift = low CWL deviation at non-perpendicular incidence of radiation

⁴ Low TC = low temperature coefficient of the CWL

The Products

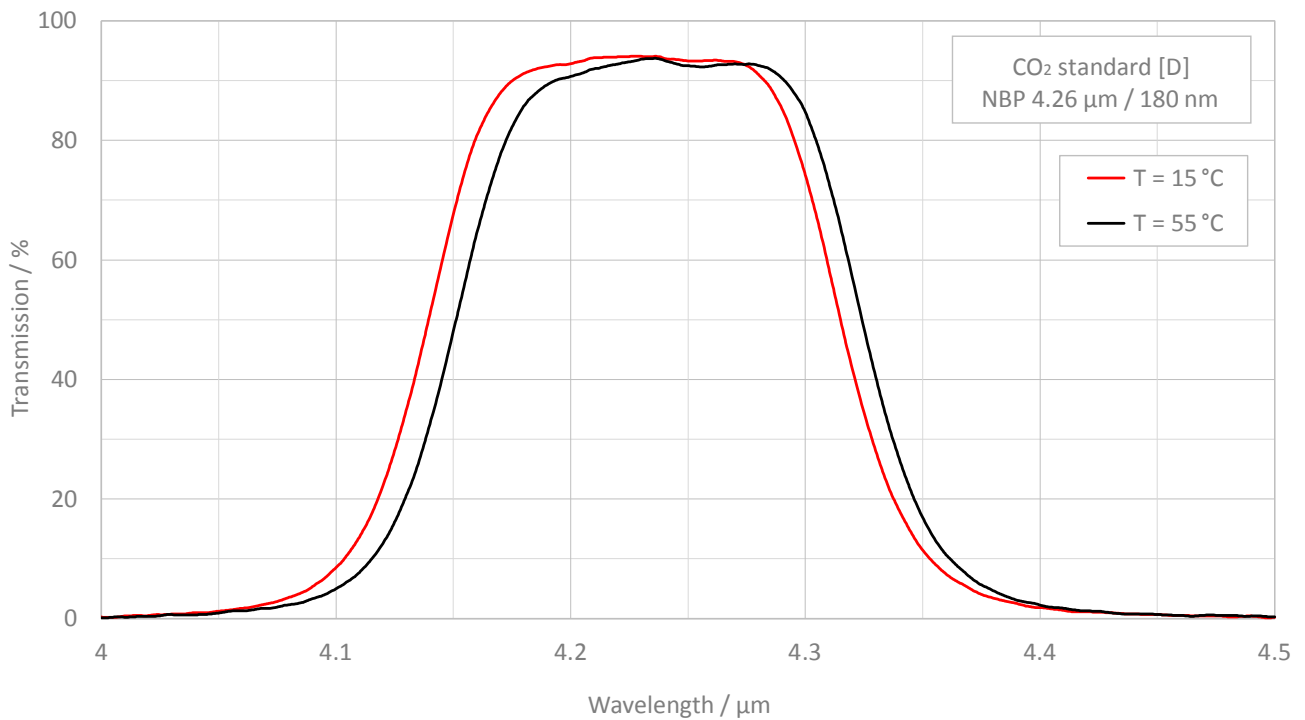

Diagram 3: Influence of the temperature increase on CWL

The influence of the angular and temperature drift is illustrated in the spectra presented here based on the example of the InfraTec D filter (low-TC design). In this case, the influence on the CWL by a temperature increase of 40 K is less (diagram 3) than by a change in the angle of incidence from 0° to 15° (diagram 4).

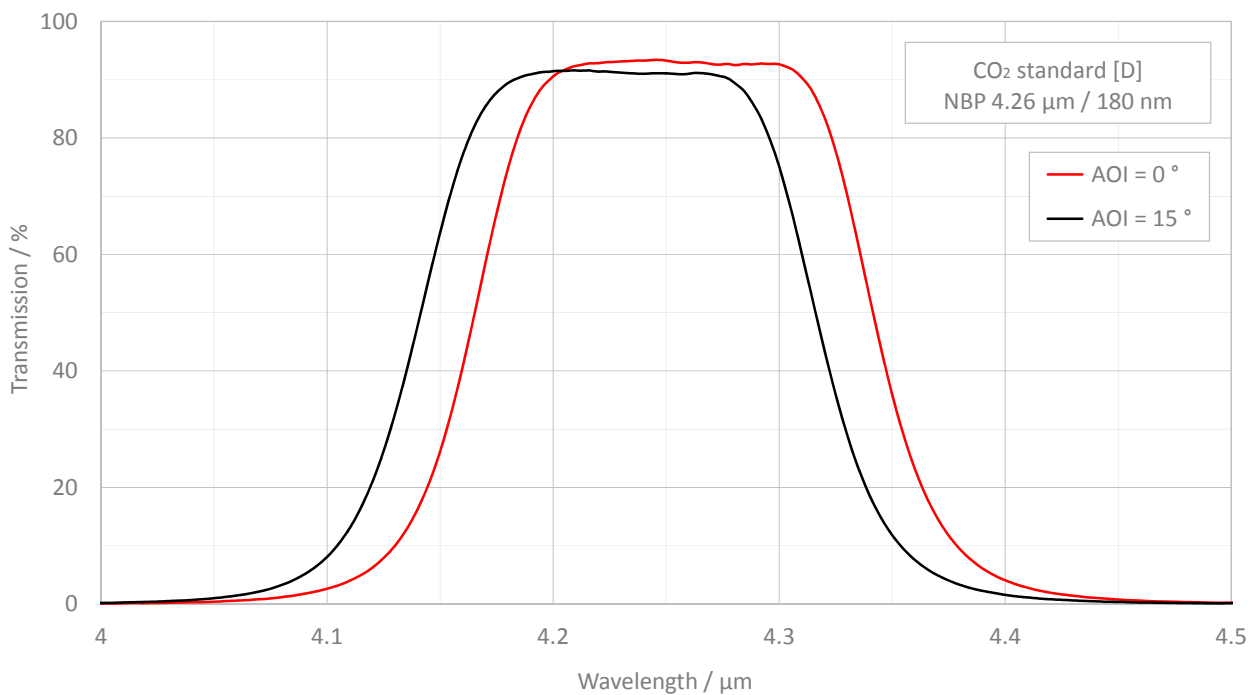
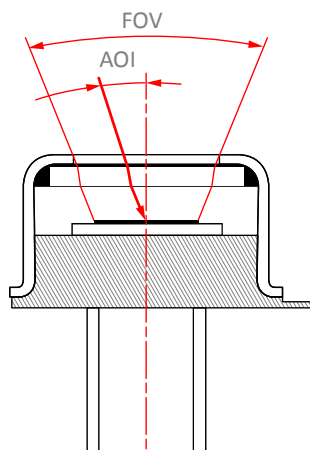

Diagram 4: Impact of changes of the angle of incidence on CWL

The Products

2.4.7 Field of View of the Detector



The field of view of the detector (FOV) is an important parameter for applications as well as for the flame sensors. However, this is defined differently from manufacturer to manufacturer. InfraTec uses as FOV the opening angle at which the pyro chip is just fully illuminated.

If, however, one defines the FOV so that even a partial illumination is admitted, one get a numerically larger opening angle. However, the signal remains the same, of course. This means that a higher performance is inferred here, which does not really exist.

The FOV should be chosen optimally in order to maximise the portion of the desired radiation or to minimise the portion of the undesired radiation. The maximum AOI should be significantly smaller than the half FOV for the gas analysis considering the CWL shift of the IR filter.

The FOV can be increased by a filter substrate with a higher refractive index and by a decrease of the distance between the pyro chip and filter. The following table specifies the FOV for different detector types and windows as an example.

Optical channels	Type of detector	FOV for different filter substrates		
		CaF ₂ / BaF ₂ 0.4 mm thick	Silicon 0.5 mm thick	Silicon 1.0 mm thick
Single channel detector	LIE-316	65°	70°	80°
	LME-335	80°	90°	110°
Multi channel detector	LIM-222	-	20°	25°
	LMM-244	-	50°	70°
Multi channel detector	LRM-254*	-	70°	60°
	LRM-202*	-	60°	50°

* Central window Si 0.5 mm

The Products

2.4.8 Customer-Specific Filters in InfraTec Detectors

Highly accurate measurements often require application-specific IR filters. InfraTec also provides the option of installing customer-specific filters in the detectors for prototyping and volume production. To do this InfraTec provides two different options:

1. Specification by the customer and purchasing by InfraTec.

In this case InfraTec will take complete responsibility for complying with the specification, the purchasing and the processing of the filters.

2. Purchasing and provision by the customer.

In this case the customer assures that the filters have the required properties, can be easily processed and especially can be assembled considering the conditions of a series production into the detectors. The incoming goods inspection is limited here to the spot checking of the spectral properties of CWL and HPBW.

Generally filter chips already diced to the right size at the manufacturer should be provided. The correct measurements and tolerances for the respective detector type can be found in the associated data sheets under "Filter sizes". The standard thickness for all filters is $0.5^{+0.2}_{-0.1}$ mm. In many InfraTec detectors, however, filter chips with a thickness of up to 1.1 mm can be used.

From the number of ordered detectors considering the yield we calculate the number of filters to be provided and communicate it to you. For taking quality features into consideration we ask you to tell us the name of the filter manufacturer.

For supporting the design-in phase we can also dice supplied IR wafers on Si or Ge substrate to the required chip size for sample quantities. In this case of course InfraTec cannot take any responsibility for delamination of the filter layer or any other damage that could occur when dicing.

Please contact us before ordering a filter so that we can check the technical feasibility together.

The sensitive IR filters must be shipped in suitable packing. We recommend:

- Singularised chips in fitting waffle pack
- Diced chips on dicing film (e.g. Nitto adhesive tape)

A high degree of purity is essential to ensure safe assembly and thus airtight and moisture resistant sealing between the filter chip and detector cap. For this reason, at least cleanroom similar conditions should be maintained when handling the filters. The supplied filters should not have any contaminations, fingerprints, residues from ink pens, adhesives, putties or films. On wafers, any surfaces that are damaged or cannot be used for other reasons (e.g. because of engraved inscriptions) must be clearly identified (inked).

Do you have any questions about using customer-specific filters and windows? Our experts will be pleased to advise you at any time.

The Products

2.4.9 Transmission Spectrums of the Standard NBP Filters

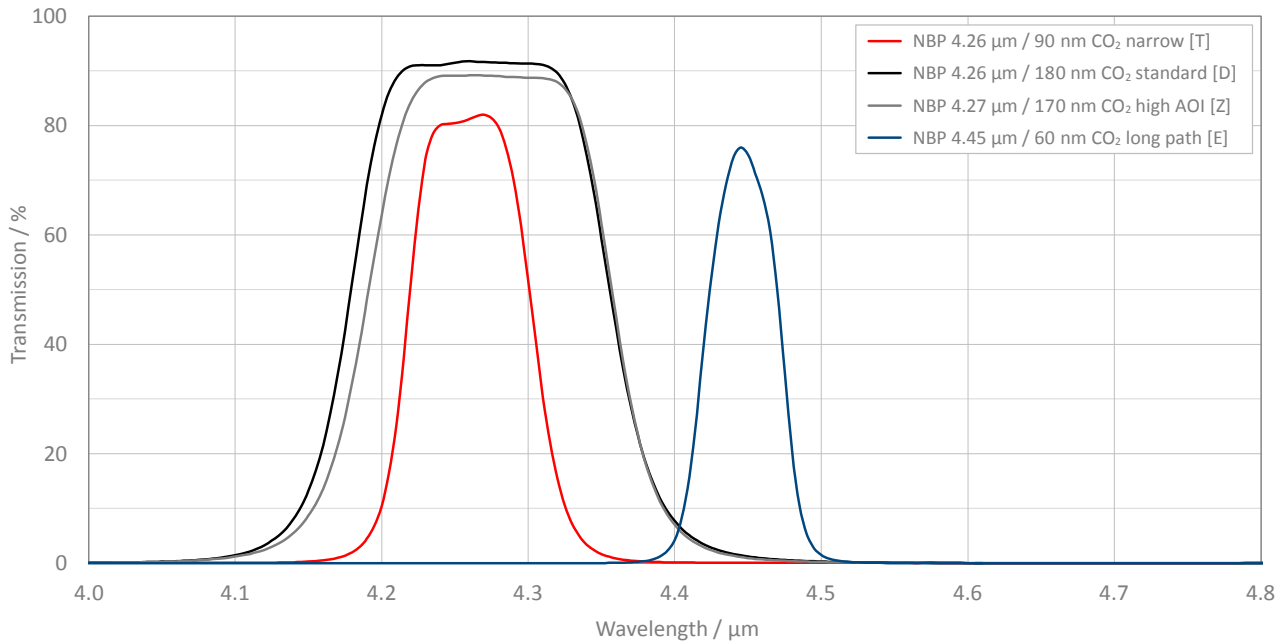

Diagram 5: NBP Filter for measuring carbon dioxide

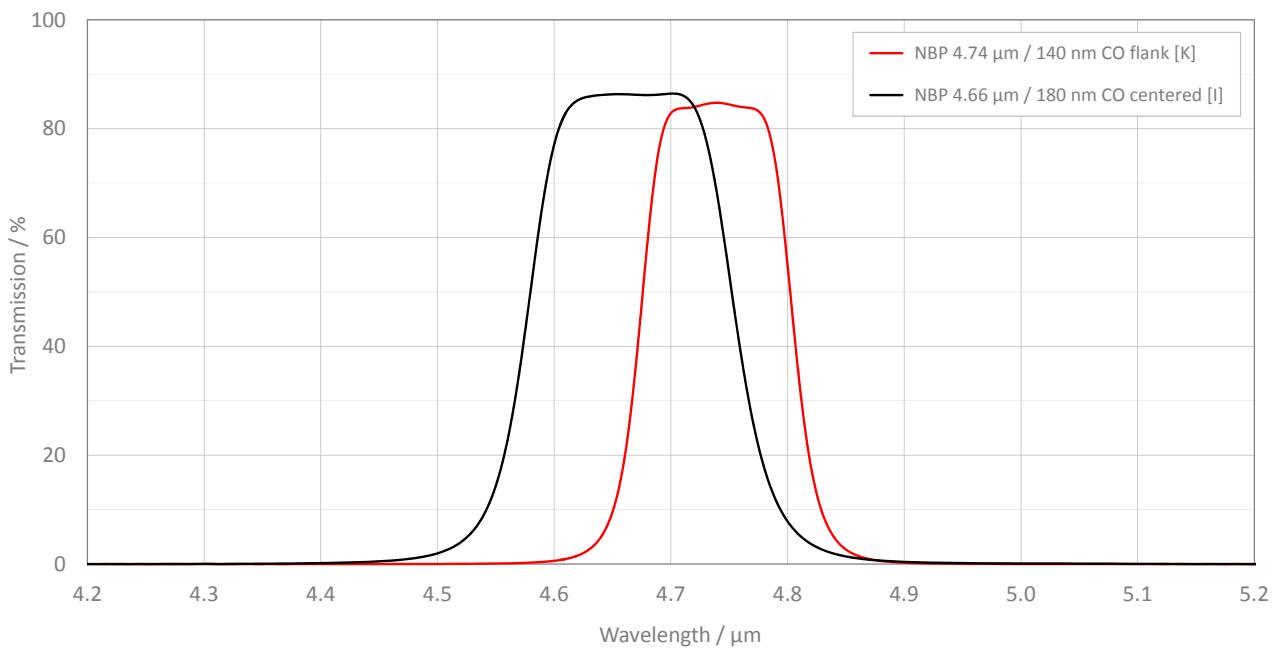

Diagram 6: NBP filter for measuring carbon monoxide

The Products

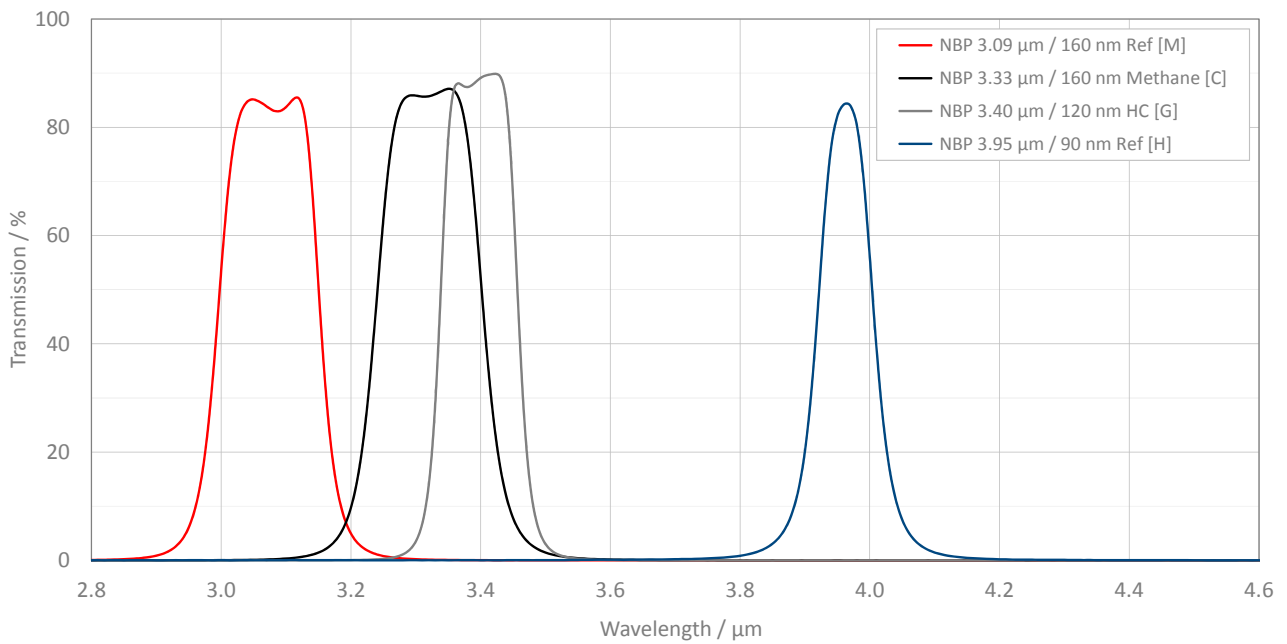

Diagram 7: NBP filter for measuring hydrocarbons and reference filters

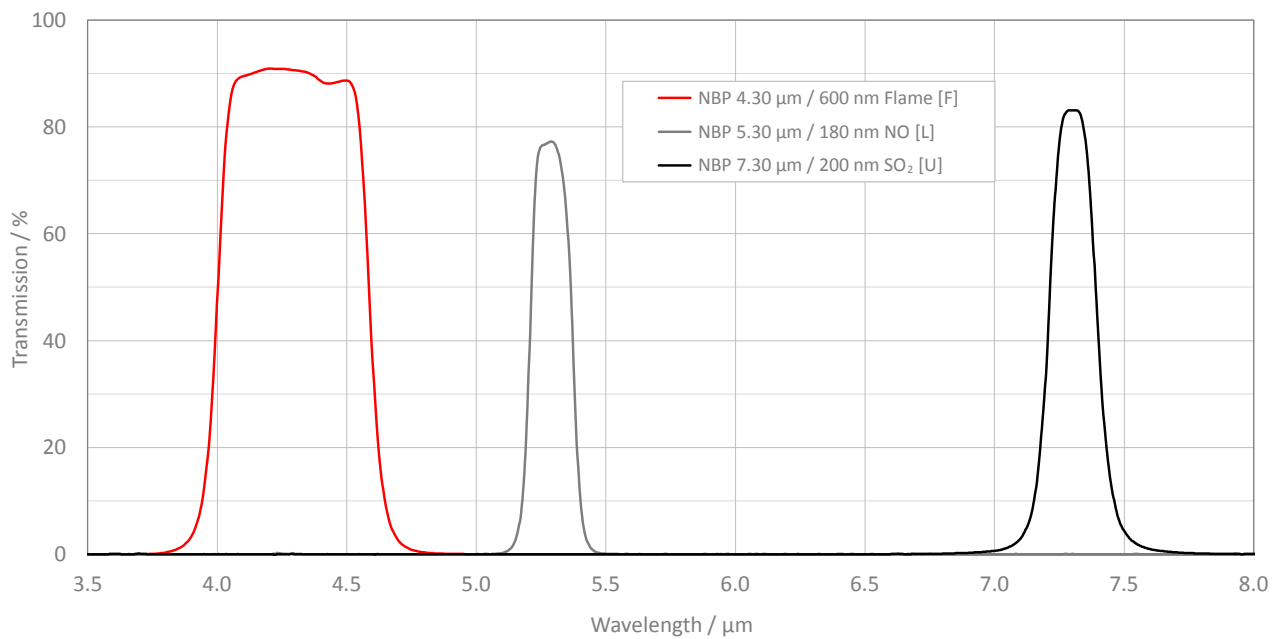

Diagram 8: NBP filter for flame detection as well as measuring nitrogen monoxide and sulphur dioxide

The Products

2.4.10 Transmission Spectrums of the Standard Windows

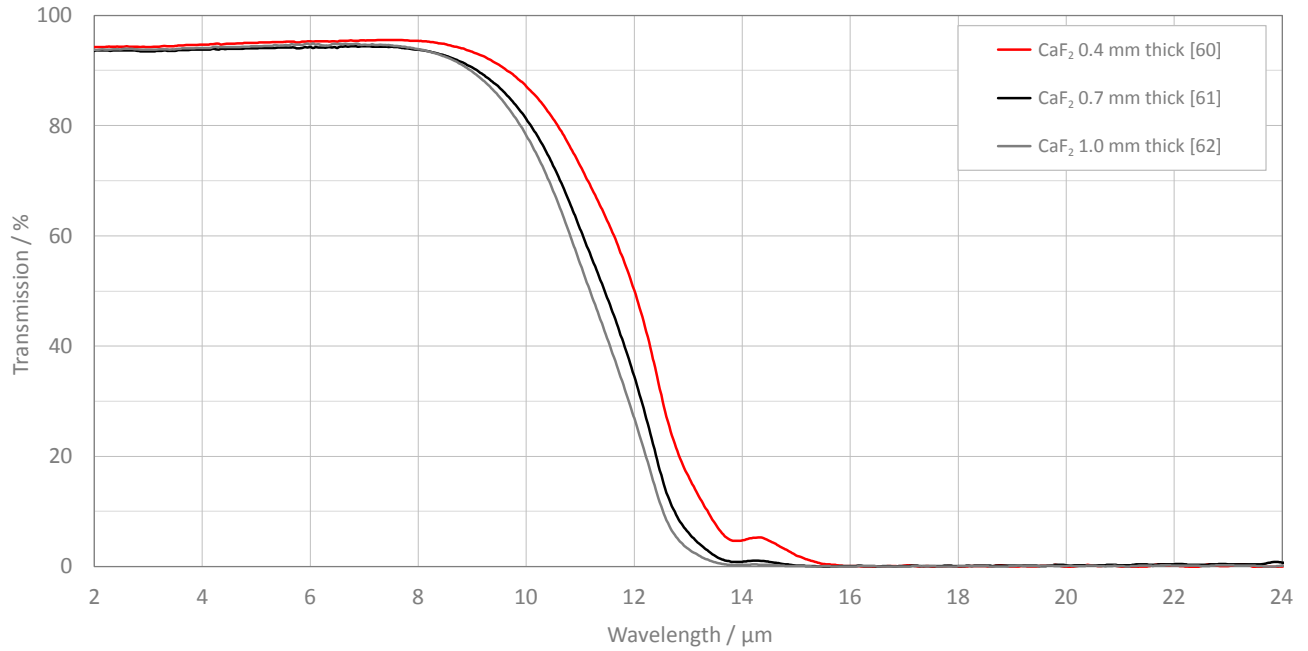

Diagram 9: Calcium fluoride

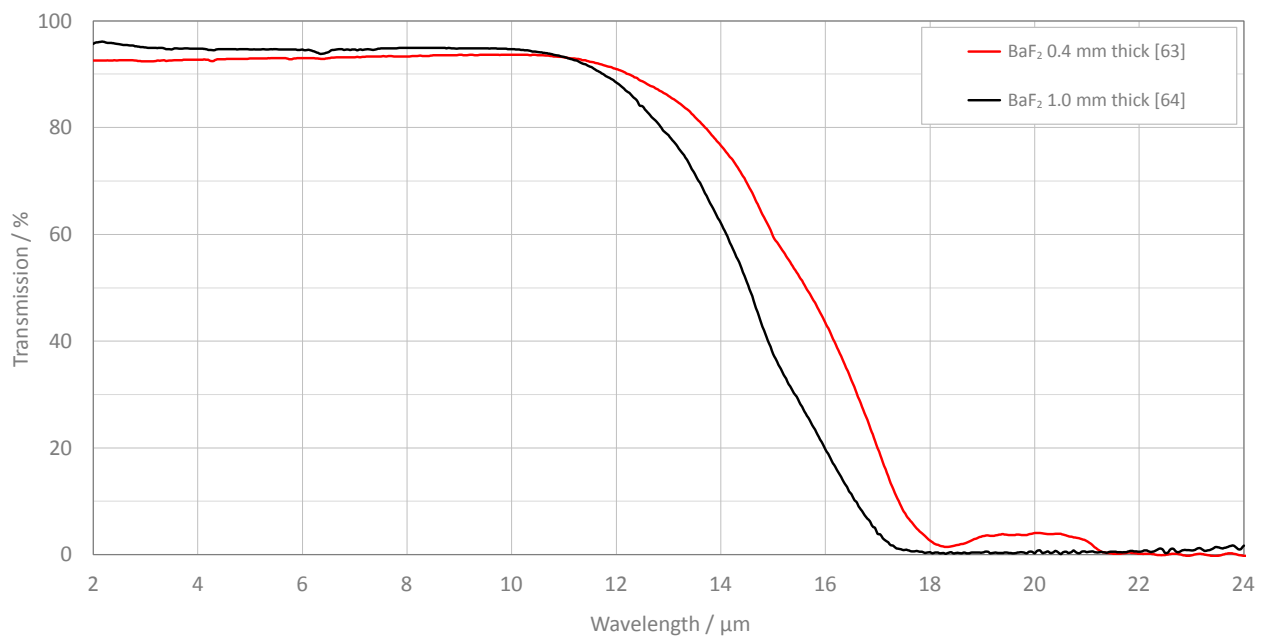

Diagram 10: Barium fluoride

The Products

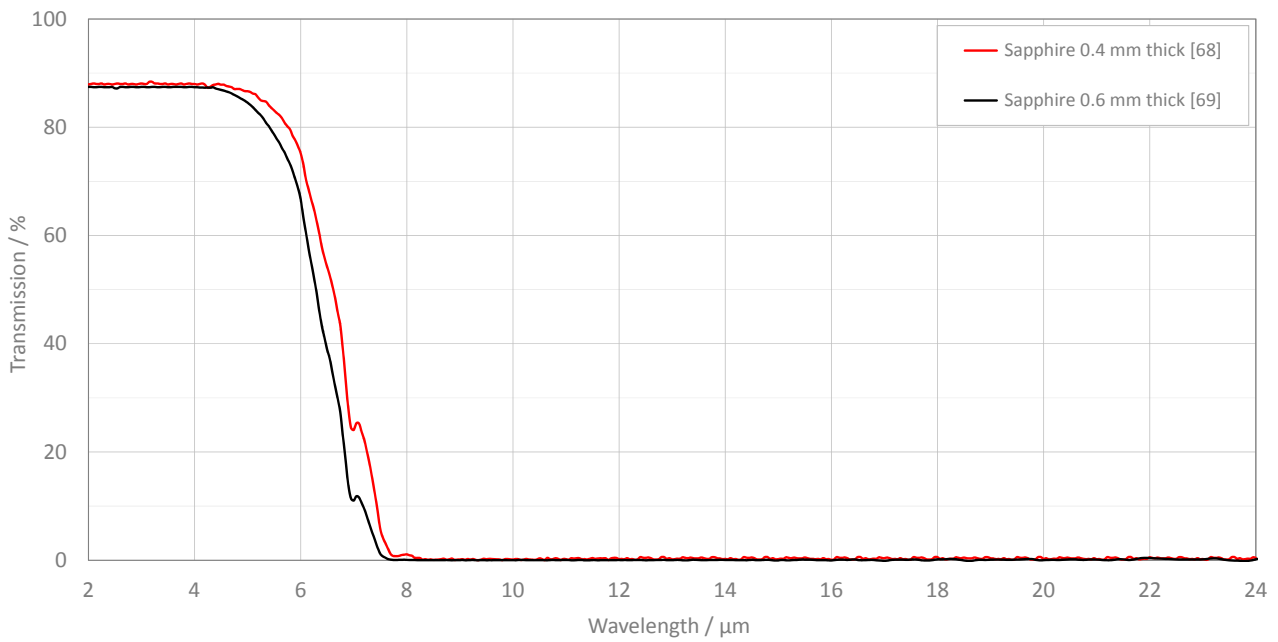

Diagram 11: Sapphire

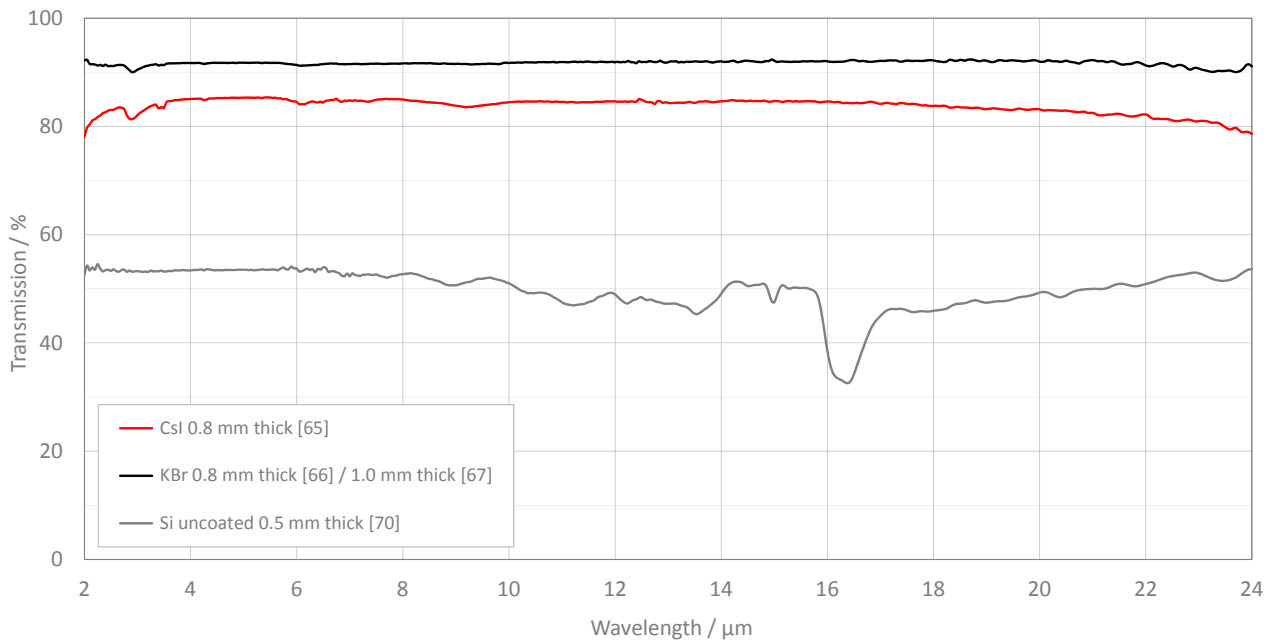

Diagram 12: Materials with a large spectral transmission range

The Products

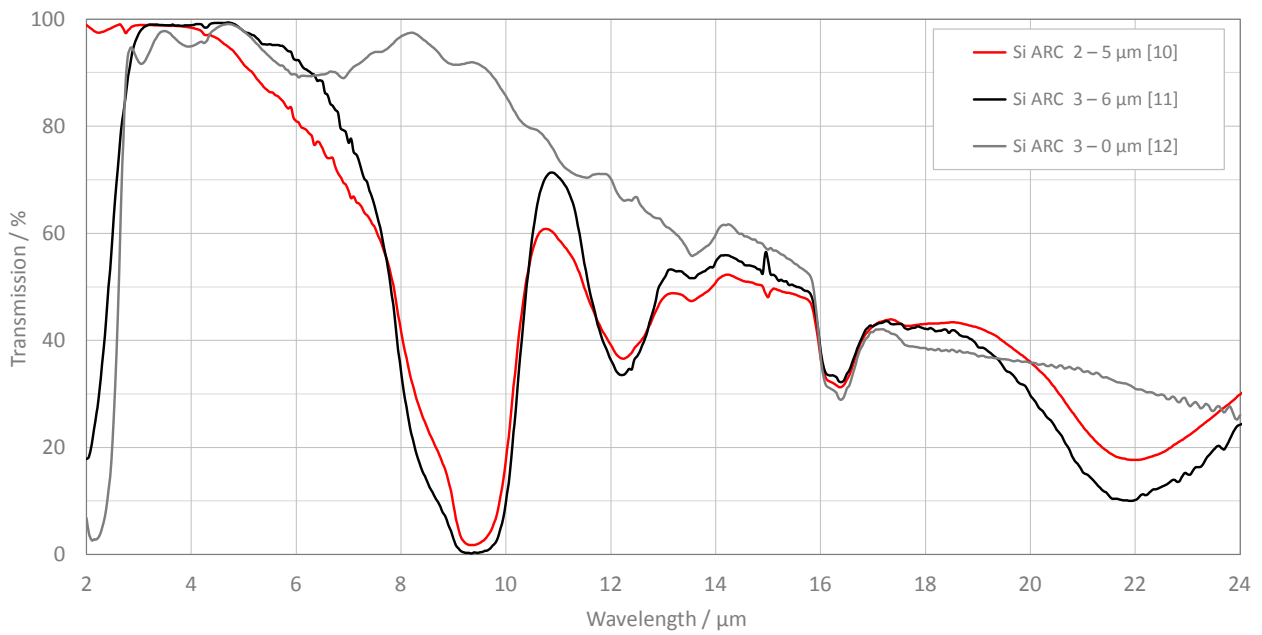

Diagram 13: Silicon windows with antireflective coating

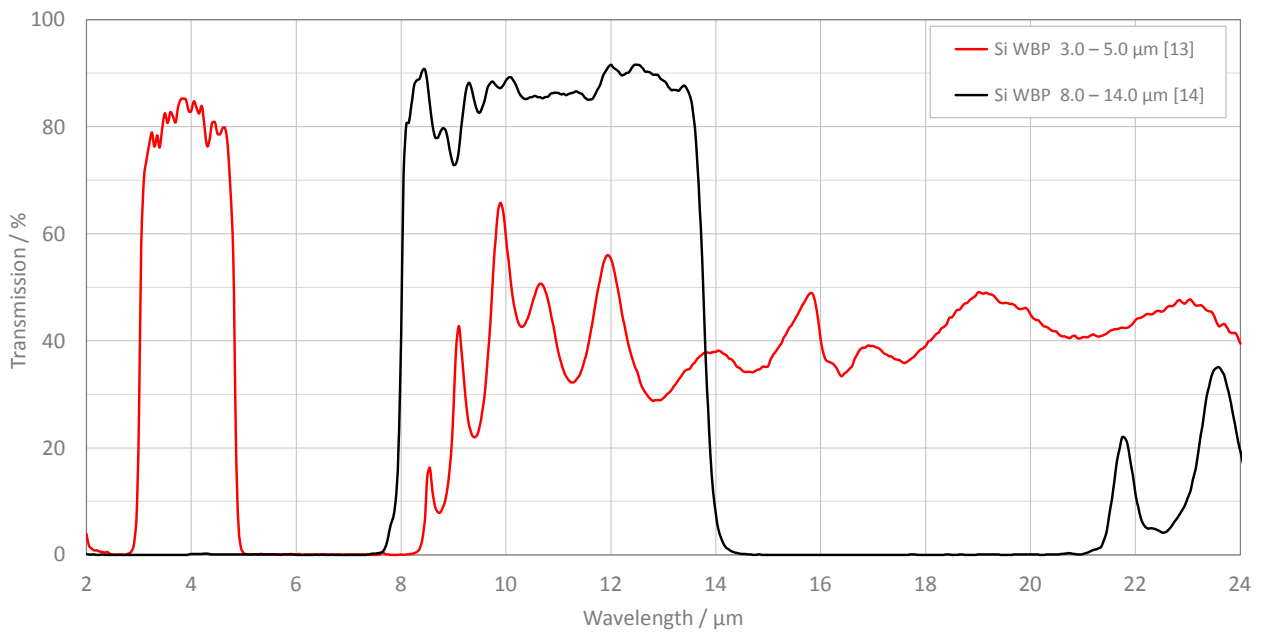

Diagram 14: Silicon-based wideband passes (WBP)

The Products

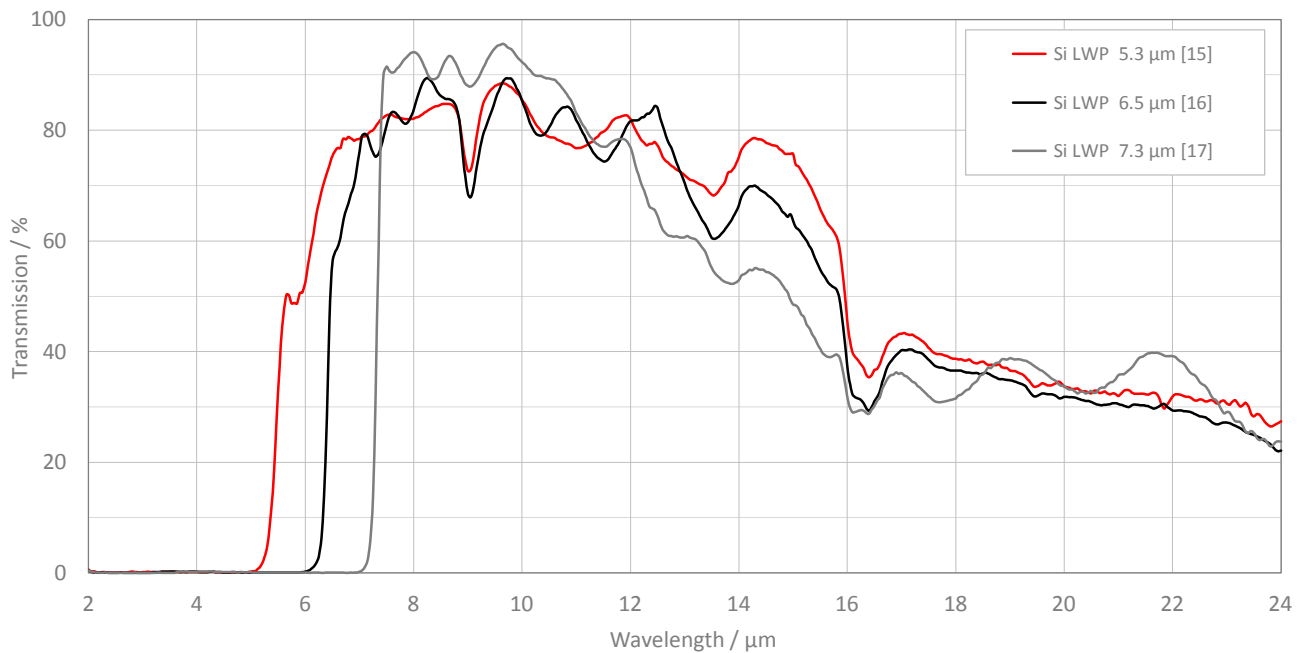

Diagram 15: Silicon-based longwave passes (LWP)

2.4.11 Quality

Filters and windows of the detectors from InfraTec comply with MIL-F-48616, a specification for purchasing IR interference filters for the US army. For military new developments it is not anymore in use (inactive), but still valid and is used very frequently in non-military fields because of lack of comparable standards there.

- Surface quality: F-F
- Resistance to environmental influences
 - Temperature § 4.6.9.1
 - Humidity § 4.6.8.2
 - Medium abrasion resistance § 4.6.8.3
 - Adhesion § 4.6.8.1
 - Solubility and possibility for cleaning § 4.6.9.2

Headquarters

InfraTec GmbH

Infrarotsensorik und Messtechnik

Gostritzer Str. 61 – 63

01217 Dresden / GERMANY

Phone +49 351 871-8625

Fax +49 351 871-8727

E-mail sensor@InfraTec.de

Internet www.InfraTec.de

USA office

InfraTec infrared LLC

Plano, TX / USA

Phone +1 877 797 6748

Fax +1 877 389 2668

E-mail sensor@InfraTec-infrared.com

Internet www.InfraTec-infrared.com

Chesterfield

Headquarters
Dresden

Shanghai

UK office

InfraTec infrared Ltd.

Chesterfield / UK

Phone +44 1246 267562

Fax +44 1246 269381

E-mail sensor@InfraTec.co.uk

Internet www.InfraTec.co.uk

China office

InfraTec Representative

Greater China

c/o German Industry & Commerce

Greater China

Shanghai / PEOPLE'S REPUBLIC OF CHINA

Phone +8621 68758536 ext 1633

E-mail sensors@InfraTec.cn

Internet www.InfraTec.cn



Latest information on the internet.

Picture credits

fotolia: © photoworld, © Andrey Popov, © VRD, © shamtor, © ff-fotodesign, © sabdesign85

istockphoto: © TonyTaylorStock, © Peshkova